

DO NOT SCALE FROM THIS PRINT

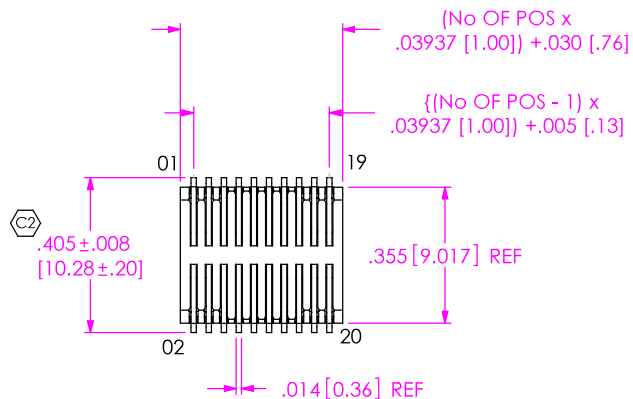

NO. OF POSITIONS

THREADED: -10, -20, -25, -30, -40, -50
 NON-THREADED: -05 THRU -50
 [IN MULTIPLES OF 5]

BODY HEIGHT

-06: 6mm (USE C-133-02-XXX)
 -10: 10mm (USE C-133-03-XXX)

PLATING

- L: .00010 GOLD ON CONTACT AREA, .000100-.000250 TIN ON TAIL (USE C-133-XX-L)
- S: .000030 GOLD ON CONTACT AREA, .000100-.000250 TIN ON TAIL (USE C-133-XX-S)
- STL: .000030 GOLD ON CONTACT AREA, .000200 TIN LEAD ON TAIL (USE C-133-XX-STL)
- LTL: .000010 GOLD ON CONTACT AREA, .000200 TIN LEAD ON TAIL (USE C-133-XX-LTL)
- LM: .000010 GOLD ON CONTACT AREA, .000100-.000250 MATTE TIN ON TAIL (USE C-133-XX-L)
- SM: .000030 GOLD ON CONTACT AREA, .000100-.000250 MATTE TIN ON TAIL (USE C-133-XX-S)

OPTION

- TR: TAPE & REEL PACKAGING BLANK FOR TUBED PARTS.
- P: (FOR AVAILABILITY, SEE FIG. 4, SHEET 3)
- K: POLYAMIDE FILM PAD (USE K-500-300) (SEE FIG. 5, SHEET 3) (AVAILABLE ONLY ON POSITIONS 40 & 50 WITH ANY THREADED INSERT OPTIONS)

ALIGNMENT PIN LOCATION

- AT: TOP SIDE (USE FSI-XX-XX-D-AT-X)
- AB: BOTTOM SIDE (USE FSI-XX-XX-D-AB-X)
- AD: DUAL (TOP & BOTTOM) (USE FSI-XX-XX-D-AD-X, SEE FIG. 2)
- LC: LOCKING CLIP (NOT TOOLED AT THIS TIME) BLANK FOR NO ALIGNMENT PIN.

THREADED INSERT OPTION

- E: THREADED INSERT (ENGLISH) (USE INS-19-2-56-157, SEE FIG. 3, SHT 2)
- M: THREADED INSERT (METRIC) (USE INS-19-M2-157-N, SEE FIG. 3, SHT 2)
- BLANK FOR NON-THREADED INSERT.

ROW SPECIFICATION

- D: DOUBLE ROW (FOR -06 BODY: USE FSI-XX-06-D-XX-X) (FOR -10 BODY: USE FSI-XX-10-D-XX-X)

FIG. 1 (FSI-110-06-XXX-D SHOWN)

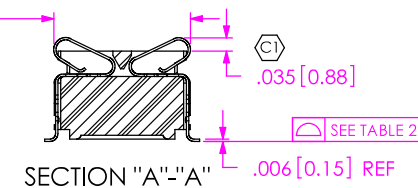
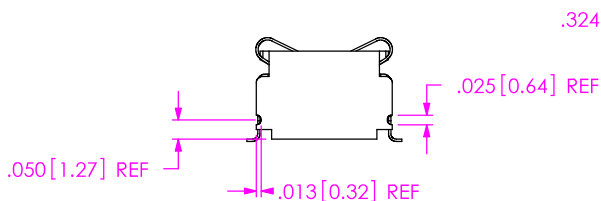
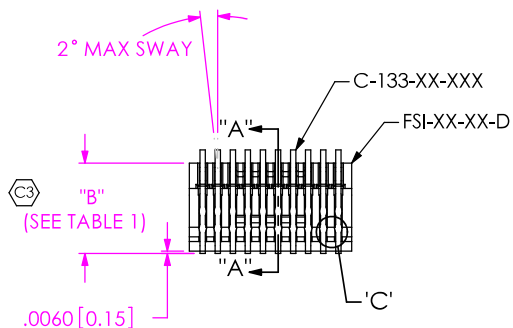
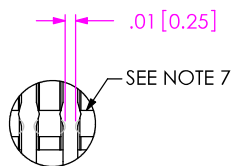

TABLE 1			
BODY HEIGHT	"B"	"C"	"D"
-06	.236 [6.00]	.450 [11.43]	.158 [4.01]
-10	.394 [10.00]	.450 [11.43]	.307 [7.80]

TABLE 2 (C4)	
No. OF POS.	COPLANARITY
0-35	.004 [.10]
40-50	.006 [.15]



DETAIL 'C' SCALE 5.5 : 1

NOTES:

1. (C) REPRESENTS A CRITICAL DIMENSION.
2. MINIMUM PUSHOUT FORCE: 12 oz.
3. LOAD INSERTS IN THE DIRECTION OF THE ARROW USING THERMAL INSERTION MACHINE; FLUSH TO .003 RECESSED.
4. THREADED INSERT MUST BE ABLE TO HANDLE 54 in-oz's OF TORQUE MIN WITHOUT ROTATING OR "LOOSENING".
5. THREADED INSERT RETENTION TO BE 50 lb MIN.
6. FOR -05 POS WITH -PPP OPTION, LEADS MAY NOT BE VISIBLE BY SOME OPTICAL MACHINES.
7. HOT BAR FORM AFTER ASSEMBLY (WILL PRODUCE RETENTION FLANGE AS SHOWN).

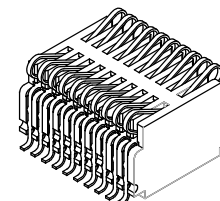

IN-PROCESS
 [SHOWN WITH CARRIER]

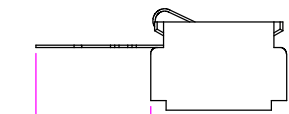

IN-PROCESS 2
 [SHOWN WITH CARRIER]

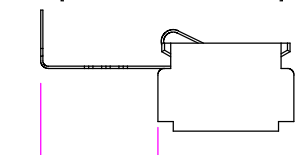

UNLESS OTHERWISE SPECIFIED, DIMENSIONS ARE IN INCHES.

TOLERANCES ARE:

DECIMALS ANGLES
 .XX: ±.01 [.25]
 .XXX: ±.005 [.13]
 .XXXX: ±.0020 [.05]

PROPRIETARY NOTE

THIS DOCUMENT CONTAINS INFORMATION CONFIDENTIAL AND PROPRIETARY TO SAMTEC, INC. AND SHALL NOT BE REPRODUCED OR TRANSFERRED TO OTHER DOCUMENTS OR DISCLOSED TO OTHERS OR USED FOR ANY PURPOSE OTHER THAN THAT WHICH IT WAS OBTAINED WITHOUT THE EXPRESSED WRITTEN CONSENT OF SAMTEC, INC.

MATERIAL: DO NOT SCALE DRAWING SHEET SCALE: 2:1

INSULATOR: LCP, COLOR: BLACK
 CONTACTS: C-133-02-X; BeCu
 C-133-03-X; BeCu

INSERT: BRASS

F:\DWG\MISC\MKTG\FSI-1XX-XX-XXX-D-X-XX-XX-MKT.SLDDRW

SAMTEC

520 PARK EAST BLVD, NEW ALBANY, IN 47150
 * PHONE: 812.944.6733 FAX: 812.948.5047
 e-Mail: INFO@SAMTEC.COM CODE: 55322

DESCRIPTION:
 1mm SINGLE ELEMENT INTERFACE

DWG. NO.
FSI-1XX-XX-XXX-D-X-XX-XX

BY: BRATCHER 1/29/99 SHEET 1 OF 3

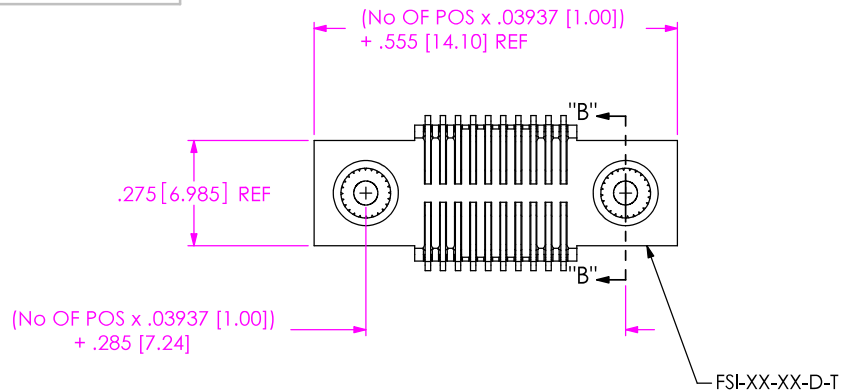
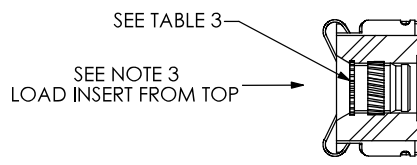

FIG. 3
-M & -E: THREADED OPTIONS
(FSI-110-06-L-D-M SHOWN)
(EQUATIONS APPLY TO -10, -20, -25 & -30 ONLY)



SECTION "B"- "B"

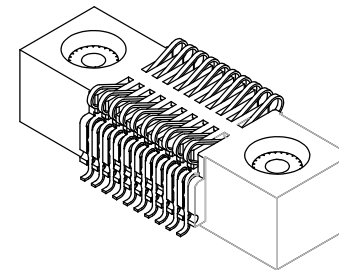
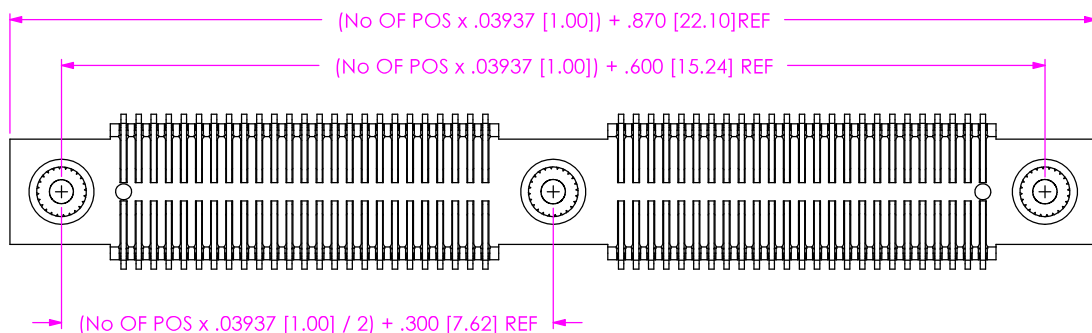

TABLE 3: THREADED INSERT		
OPTION	INSERT	THREAD
-E	INS-19-2-56-157	2 X 56
-M	INS-19-M2-157-N	M2.0 x 4

**** METRIC THREADED INSERTS TO BE FLASH NICKEL PLATED**



FOR -40- & -50 WITH -M OR -E OPTION
(FSI-150-06-L-D-AD-M SHOWN)

FIG. 2
ALIGNMENT PIN OPTIONS
(FSI-110-06-L-D-AD SHOWN)

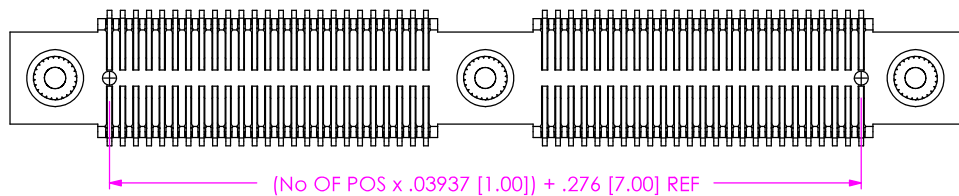

AK

ALIGNMENT PIN OPTION
FOR -40- & -50 WITH -M OR -E OPTION
(FSI-150-XX-L-D-AD-M SHOWN)

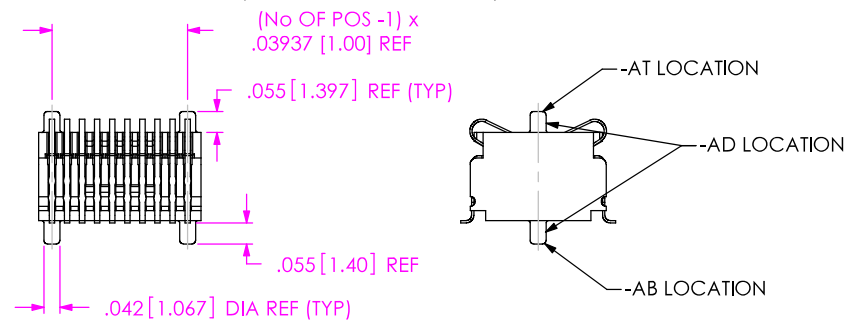

PROPRIETARY NOTE
THIS DOCUMENT CONTAINS INFORMATION CONFIDENTIAL AND PROPRIETARY TO SAMTEC, INC. AND SHALL NOT BE REPRODUCED OR TRANSFERRED TO OTHER DOCUMENTS OR DISCLOSED TO OTHERS OR USED FOR ANY PURPOSE OTHER THAN THAT WHICH IT WAS OBTAINED WITHOUT THE EXPRESSED WRITTEN CONSENT OF SAMTEC, INC.

DO NOT SCALE DRAWING

SHEET SCALE: 2:1

SAMTEC
520 PARK EAST BLVD, NEW ALBANY, IN 47150
PHONE: 812.944.6733 FAX: 812.948.5047
e-Mail: INFO@SAMTEC.COM CODE: 55322

DESCRIPTION:
1mm SINGLE ELEMENT INTERFACE

DWG. NO.
FSI-1XX-XX-XXX-D-X-XX-XX

BY: BRATCHER 1/29/99 SHEET 2 OF 3

FIG. 4

-P: PICK & PLACE PAD OPTION
(FSI-110-06-L-D-M SHOWN)
NOT AVAILABLE ON 5 POSITION

NOT AVAILABLE IF POSITION IS 05 AND LEAD STYLE IS 06

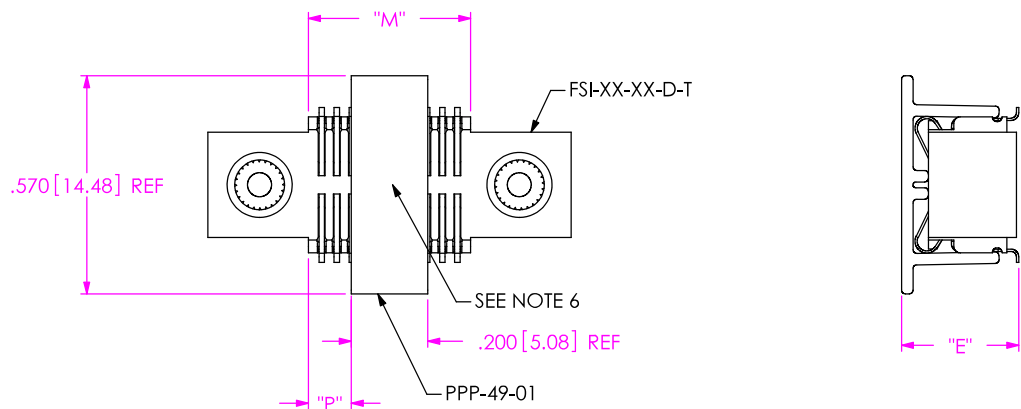

FOR 10 THRU 50 POSITIONS WITH -M OR -E OPTION,
-10 THRU -50 WITHOUT -M OR -E OPTION

"M" = (No OF POS x .03937[1.000]) + .030[.76] REF
"P" = {("M" - .200[5.08]) / 2} ± .020[.51]

TABLE 4

BODY HEIGHT	"E"	"F"
-06	.306 [7.77]	.241 [6.12]
-10	.464 [11.79]	.399 [10.13]

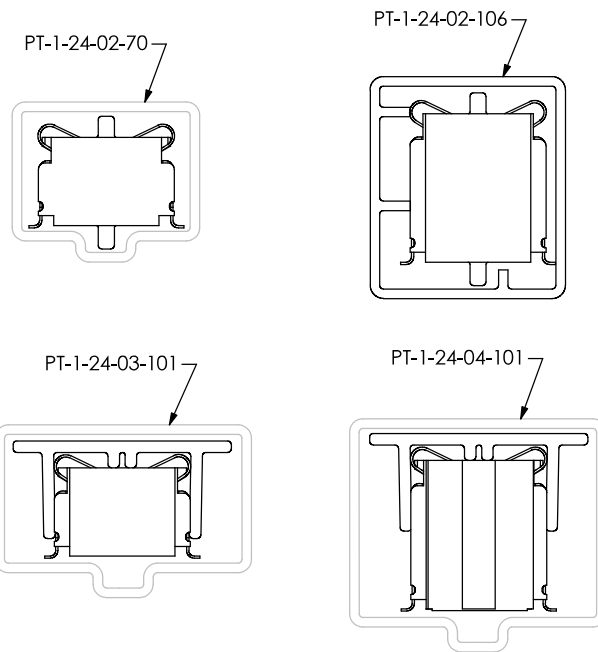

PACKAGING TABLE

BODY HEIGHT	TUBE	PLUG
-06	PT-1-24-02-70	TP-29
-10	PT-1-24-02-106	TP-13
-06-P	PT-1-24-03-101	TP-03
-10-P	PT-1-24-04-101	TP-13

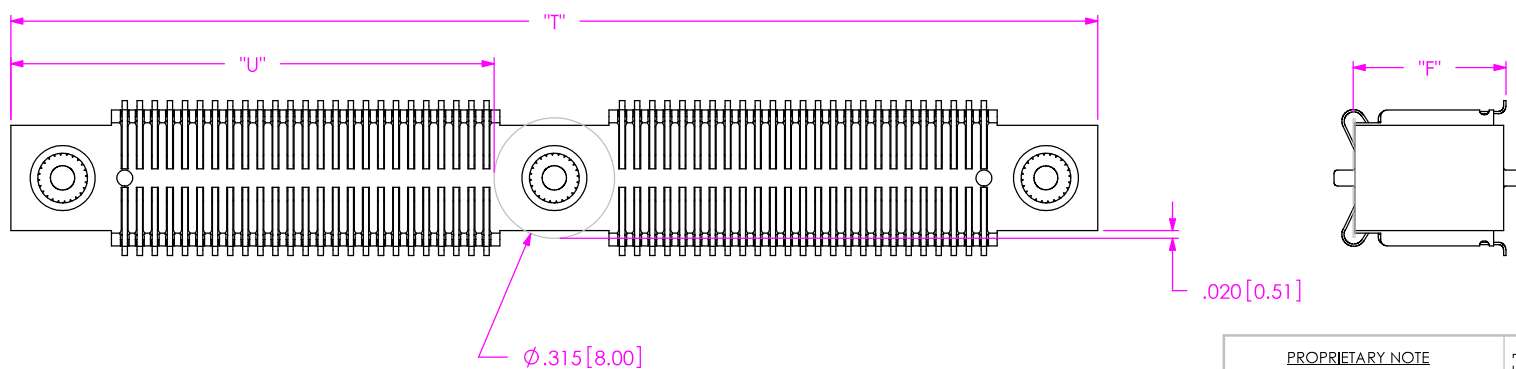

FIG. 5

-K: POLYAMIDE FILM PAD
(USE K-500-300)
(AVAILABLE ONLY ON POSITIONS
40 & 50 WITH -M OR -E OPTION)

"T" = (No OF POS x .03937[1.000]) + .870[22.10] REF
"U" = {("T" - .315[8.00]) / 2} ± .020[.51]

PROPRIETARY NOTE

THIS DOCUMENT CONTAINS INFORMATION
CONFIDENTIAL AND PROPRIETARY TO
SAMTEC, INC. AND SHALL NOT BE REPRODUCED
OR TRANSFERRED TO OTHER DOCUMENTS OR
DISCLOSED TO OTHERS OR USED FOR ANY
PURPOSE OTHER THAN THAT WHICH IT WAS
OBTAINED WITHOUT THE EXPRESSED WRITTEN
CONSENT OF SAMTEC, INC.

DO NOT SCALE DRAWING

SHEET SCALE: 2:1

SAMTEC

520 PARK EAST BLVD, NEW ALBANY, IN 47150
PHONE: 812.944.6733 FAX: 812.948.5047

EMAIL: INFO@SAMTEC.COM CODE: 55322

DESCRIPTION:
1mm SINGLE ELEMENT INTERFACE

DWG. NO.
FSI-1XX-XX-XXX-D-X-XX-XX

BY: BRATCHER 1/29/99 SHEET 3 OF 3